

ADAPTERS COMPLETE SERIES

NUVO - CONNECTIONS

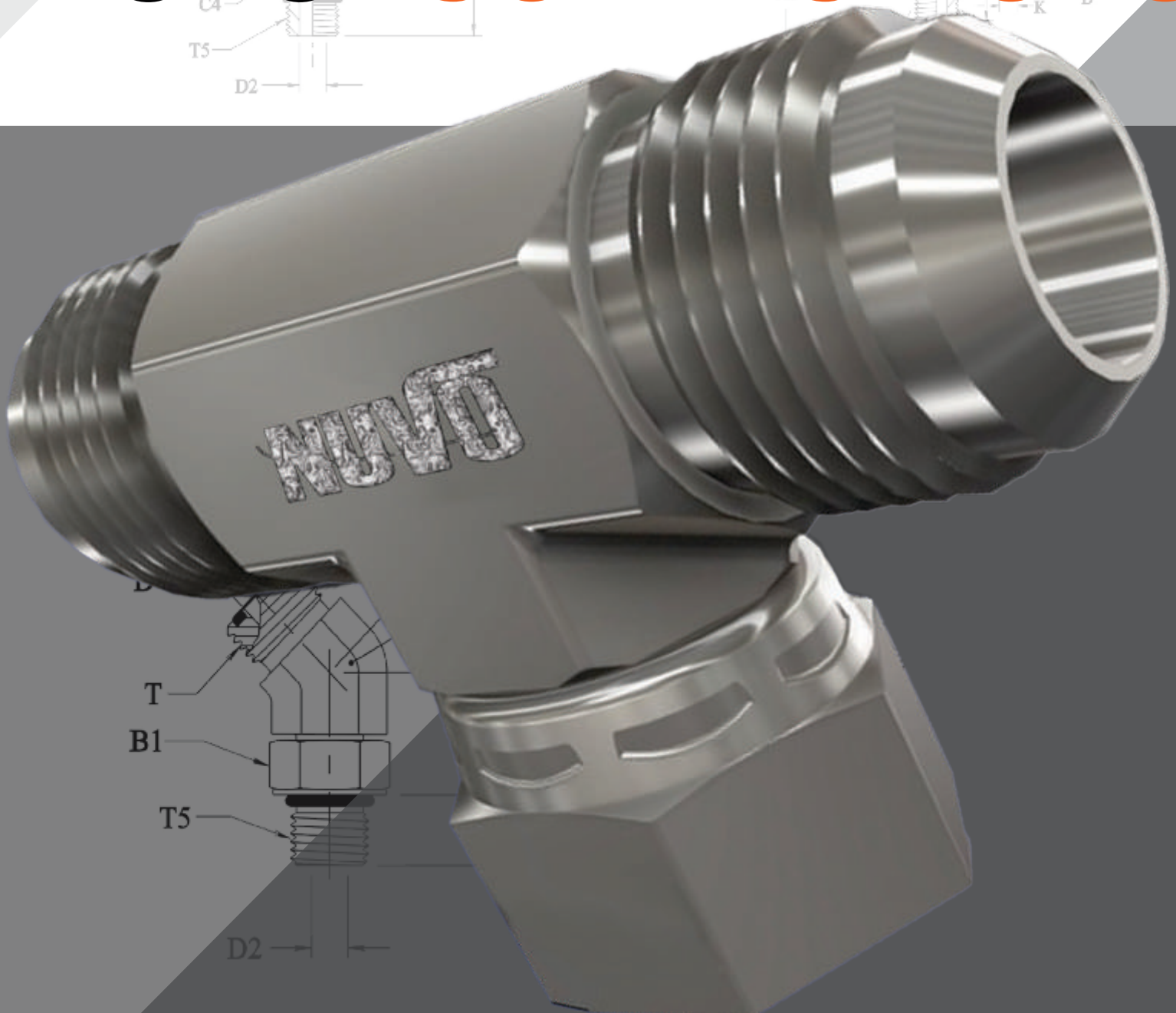

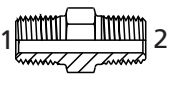
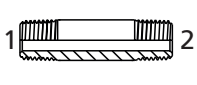
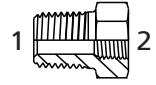

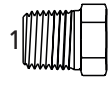

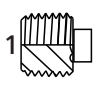

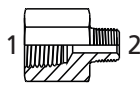
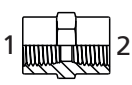
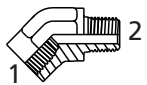
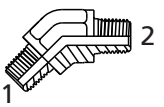
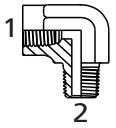
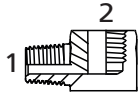
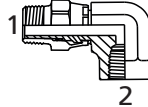
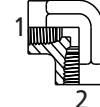
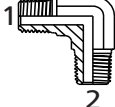
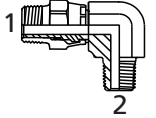
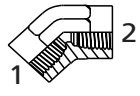
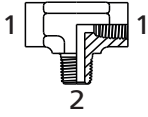
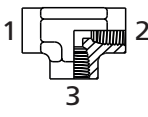
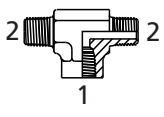
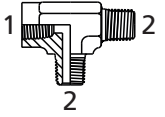

TABLE OF CONTENTS



Introduction.....	2
<i>NPT/NPSM ADAPTERS.....</i>	<i>6-7</i>
<i>JIC ADAPTERS.....</i>	<i>8..10</i>
<i>BULKHEAD ADAPTERS.....</i>	<i>11</i>
<i>ORB ADAPTERS.....</i>	<i>12-13</i>
<i>ORFS ADAPTERS.....</i>	<i>14..16</i>
<i>FLANGE ADAPTERS.....</i>	<i>16-17</i>
<i>STANDARD FLARELESS ADAPTERS.....</i>	<i>18-19</i>
<i>BSP ADAPTERS.....</i>	<i>20..23</i>
<i>METRIC ADAPTERS.....</i>	<i>24..26</i>
<i>MOBILE APPLICATION ADAPTERS.....</i>	<i>26-27</i>
<i>O’RING ADAPTERS.....</i>	<i>27</i>
<i>METRIC FLARELESS ADAPTERS.....</i>	<i>28..30</i>



NPT ADAPTERS

3069 (5404) M.NPT - M.NPT 	3069X (5404N) M.NPT - F.NPT LONG 	3109 (5406) M.NPT - F.NPT 	3149 (5406P) CAP F.NPT 	3159 (5406P) PLUG M.NPT 	3169 (5409) PLUG M.NPT HOLLOW HEX 
3170 (5410) PLUG M.NPT FLAT 	3179 (5407) PLUG M.NPT SQUARE HEAD 	3189 (5408) PLUG M.NPT SQUARE 	3209 (5405R) F.NPT - M.NPT 	3309 (5000) F.NPT - F.NPT 	3359 (5503) F.NPT - M.NPT 45° 
3369 (5501) M.NPT - M.NPT 45° 	3409 (5502) F.NPT - M.NPT 90° 	3409C (5502C-R) M.NPT - F.NPT 90° 	3439 (5702R) M.NPTS - F.NPT 90° 	3509 (5504R) F.NPT - F.NPT 90° 	3529 (5500) M.NPT - M.NPT 90° 
3539 (5700R) M.NPTS - M.NPT 90° 	3559 (5505) F.NPT - F.NPT 45° 	3609 (5604) F.NPT - M.NPT T 	3709 (5605) F.NPT T 	3719 (5601) F.NPT - M.NPT T 	3749 (5603) F.NPT - M.NPT T 

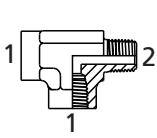
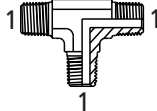
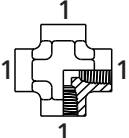

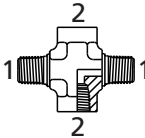
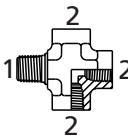



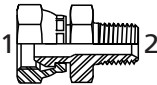
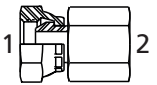
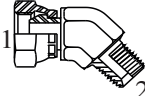
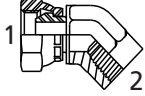
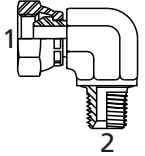
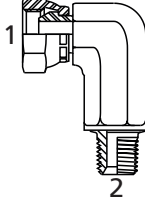
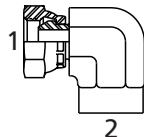
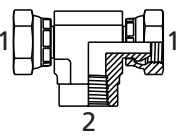
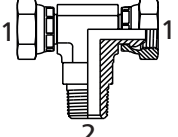
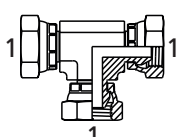
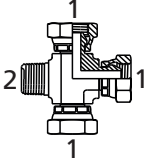

NPT ADAPTERS

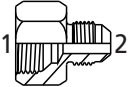
<p>3759 (5602)</p> <p>F.NPT - M.NPT T</p> 	<p>3809 (5600)</p> <p>M.NPT T</p> 	<p>3959 (5652)</p> <p>F.NPT CROSS</p> 	<p>3960 (5650)</p> <p>M.NPT CROSS</p> 	<p>3961 (5653)</p> <p>M.NPT - F.NPT CROSS</p> 	<p>3962 (5655)</p> <p>M.NPT - F.NPT CROSS</p> 
--	--	--	--	--	--

NPSM ADAPTERS

<p>9205 (1404R)</p> <p>F.NPSM - M.NPT</p> 	<p>9255 (1405R)</p> <p>F.NPSM - F.NPT</p> 	<p>9355 (1503R)</p> <p>F.NPSM - M.NPT 45°</p> 	<p>9385 (1504R)</p> <p>F.NPSM - F.NPT 45°</p> 	<p>9405 (1501R)</p> <p>F.NPSM - M.NPT 90°</p> 	<p>9406 (1501LR)</p> <p>F.NPSM - M.NPT 90° LONG</p> 
<p>9455 (1502R)</p> <p>F.NPSM - F.NPT 90°</p> 	<p>9456 (1602)</p> <p>F.NPSM - F.NPT T</p> 	<p>9457 (1601)</p> <p>F.NPSM - M.NPT T</p> 	<p>9458 (1603)</p> <p>F.NPSM T</p> 	<p>9459 (1604)</p> <p>F.NPSM - M.NPT CROSS</p> 	

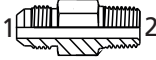
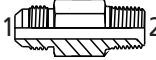
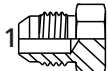
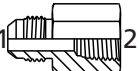

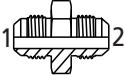
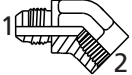
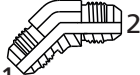
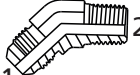
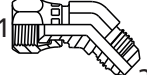
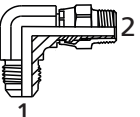
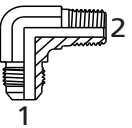
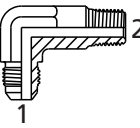
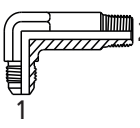
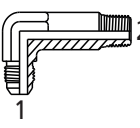
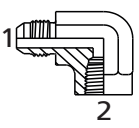

JIC 37° ADAPTERS

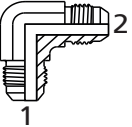
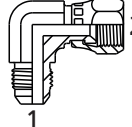
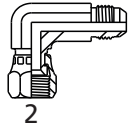
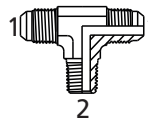
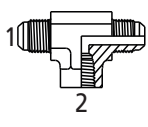
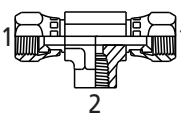
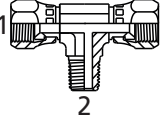
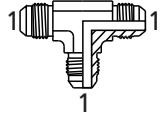
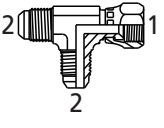
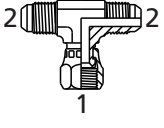
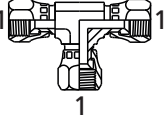
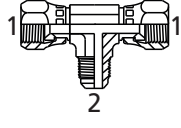
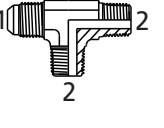
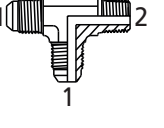
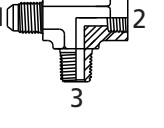
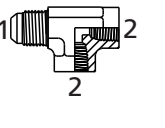
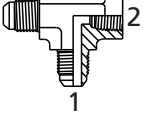
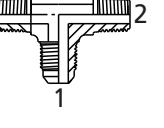
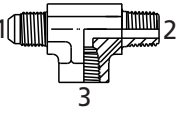
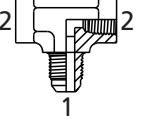
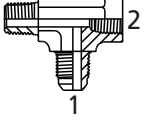
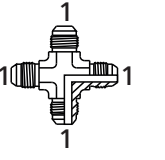
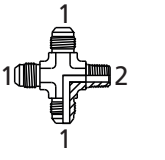
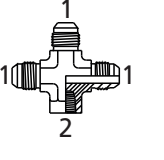
403 (0403) BORE - M.JIC 	5100 (2406) F.JIC - M.JIC 	5105 (0318) NUT F.JIC 	5106 (6504R) F.JIC - M.JIC 	5129 (0304C) CAP F.JIC 	5156 (6565) F.JIC - F.JIC 
5165 (0319) SLEEVE JIC 	5205 (2404) M.JIC - M.NPT 	5206 (2404L) M.JIC - M.NPT LONG 	5207 (2404LL) M.JIC - M.NPT X-LONG 	5229 (2408) PLUG M.JIC 	5255 (2405) M.JIC - F.NPT 
5305 (2403) M.JIC - M.JIC 	5306 (2403LH) M.JIC - M.JIC LARGE HEX 	5335 (2505) M.JIC - F.NPT 45° 	5345 (2504) M.JIC - M.JIC 45° 	5355 (2503) M.JIC - M.NPT 45° 	5356 (6502R) F.JIC - M.JIC 45° 
5403 (5701) M.JIC - M.NTPS 90° 	5405 (2501) M.JIC - M.NPT 90° 	5435 (2501L) M.JIC - M.NPT 90° LONG 	5436 (2501LL) M.JIC - M.NPT 90° X-LONG 	5437 (2501LLL) M.JIC - M.NPT 90° XX-LONG 	5455 (2502) M.JIC - F.NPT 90° 

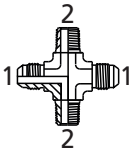
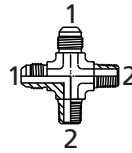

JIC 37° ADAPTERS

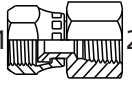
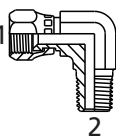
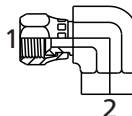
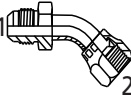
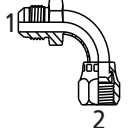
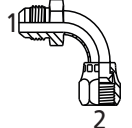
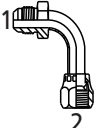
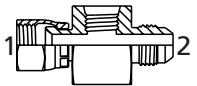
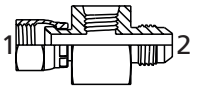
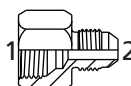
<p>5505 (2500)</p> <p>M.JIC - M.JIC 90°</p> 	<p>5506 (6500)</p> <p>M.JIC - F.JIC 90°</p> 	<p>5507 (6500L)</p> <p>M.JIC - F.JIC 90°</p> 	<p>5605 (2601)</p> <p>M.JIC - M.NPT T</p> 	<p>5655 (2602)</p> <p>M.JIC - F.NPT T</p> 	<p>5703 (6605)</p> <p>F.JIC - F.NPT T</p> 
<p>5704 (6604)</p> <p>F.JIC - M.NPT T</p> 	<p>5705 (2603)</p> <p>M.JIC T</p> 	<p>5706 (6602)</p> <p>F.JIC - M.JIC T</p> 	<p>5707 (6600)</p> <p>F.JIC - M.JIC T</p> 	<p>5708 (6606)</p> <p>F.JIC T</p> 	<p>5709 (6603)</p> <p>F.JIC - M.JIC T</p> 
<p>5745 (2607)</p> <p>M.JIC - M.NPT T</p> 	<p>5755 (2605)</p> <p>M.JIC - M.NPT T</p> 	<p>5758 (2608)</p> <p>M.JIC - F.NPT - M.NPT T</p> 	<p>5759 (2609)</p> <p>M.JIC - F.NPT T</p> 	<p>5805 (2606)</p> <p>M.JIC - F.NPT T</p> 	<p>5845 (2610)</p> <p>M.JIC - M.NPT T</p> 
<p>5846 (2611)</p> <p>M.JIC - M.NPT - F.NPT T</p> 	<p>5847 (2612)</p> <p>M.JIC - F.NPT T</p> 	<p>5849 (2613)</p> <p>M.JIC - F.NPT - M.NPT T</p> 	<p>5955 (2650)</p> <p>M.JIC CROSS</p> 	<p>5956 (2651)</p> <p>M.JIC - M.NPT CROSS</p> 	<p>5957 (2502)</p> <p>M.JIC - F.NPT CROSS</p> 





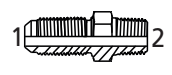
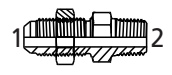
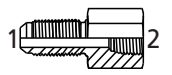
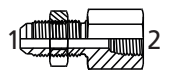
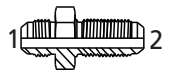
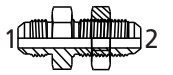
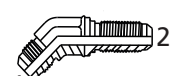
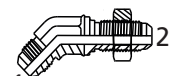
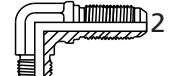
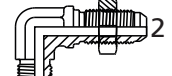
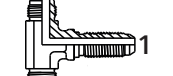
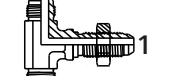
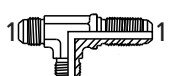
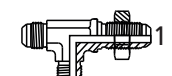

JIC 37° ADAPTERS

<p>5958 (2653)</p> <p>M.JIC - M.NPT CROSS</p> 	<p>5959 (2654)</p> <p>M.JIC - M.NPT CROSS</p> 	<p>9100 (6505R)</p> <p>F.JIC - M.NPT</p> 	<p>9256 (6506R)</p> <p>F.JIC - F.NPT</p> 	<p>9400 (6501R)</p> <p>F.JIC - M.NPT 90°</p> 	<p>9556 (6503R)</p> <p>F.JIC - F.NPT 90°</p> 
<p>9640 (6702)</p> <p>M.JIC - F.JIC 45°</p> 	<p>9690 (6701L)</p> <p>M.JIC - F.JIC 90°</p> 	<p>9690C (6701)</p> <p>M.JIC - F.JIC 90° SHORT</p> 	<p>9695 (6500BTL)</p> <p>M.JIC - F.JIC 90° LONG</p> 	<p>GP5106NPT (6574R)</p> <p>F.JIC - M.JIC GAUGE PORT NPT</p> 	<p>GP5106ORB (6564R)</p> <p>F.JIC - M.JIC GAUGE PORT ORB</p> 
<p>RES5100 (2406R)</p> <p>F.JIC - M.JIC RESTRICTOR</p> 	<p>RES5205 (2404R)</p> <p>M.JIC - M.NPT RESTRICTOR</p> 	<p>RES5405 (2501R)</p> <p>M.JIC - M.NPT RESTRICTOR</p> 			

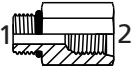
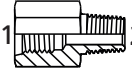
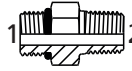
BULKHEAD ADAPTERS

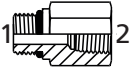
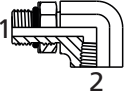
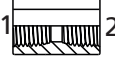
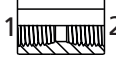
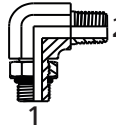
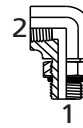
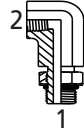
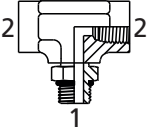
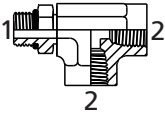
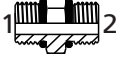
<p>5225 (2706R)</p> <p>M.JIC - M.NPT BH</p> 	<p>5225LN (2706LNR)</p> <p>M.JIC - M.NPT BH C/W LN</p> 	<p>5275 (2705R)</p> <p>M.JIC - F.NPT BH</p> 	<p>5275LN (2705LNR)</p> <p>M.JIC - F.NPT BH C/W LN</p> 	<p>5325 (2700)</p> <p>M.JIC - M.JIC BH</p> 	<p>5325LN (2700LN)</p> <p>M.JIC - M.JIC BH C/W LN</p> 
<p>5375 (2702)</p> <p>M.JIC - M.JIC 45° BH</p> 	<p>5375LN (2702LN)</p> <p>M.JIC - M.JIC 45° BH C/W LN</p> 	<p>5525 (2701)</p> <p>M.JIC - M.JIC 90° BH</p> 	<p>5525LN (2701LN)</p> <p>M.JIC - M.JIC 90° BH C/W LN</p> 	<p>5725 (2703)</p> <p>M.JIC T - BH</p> 	<p>5725LN (2703LN)</p> <p>M.JIC T - BH C/W LN</p> 
<p>5726 (2704)</p> <p>M.JIC T - BH</p> 	<p>5726LN (2704LN)</p> <p>M.JIC T - BH C/W LN</p> 	<p>5924 (0306)</p> <p>BH NUT</p> 			

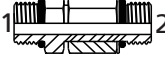
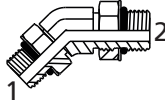
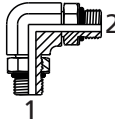
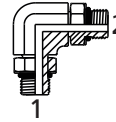

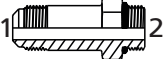
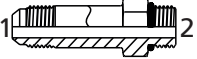
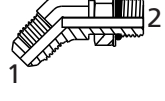



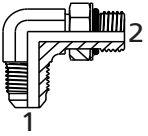
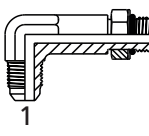
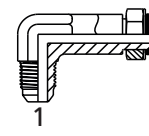
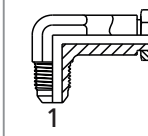
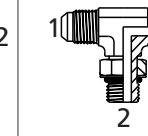
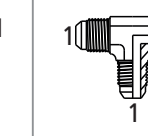
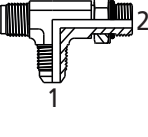
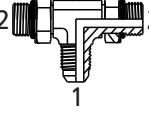
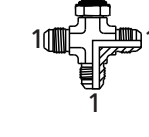
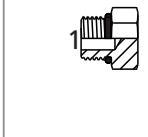
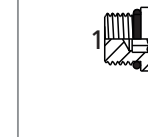
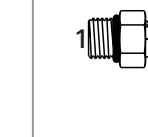
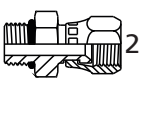
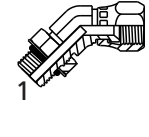
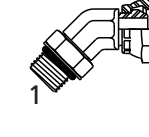
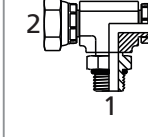
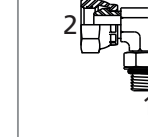
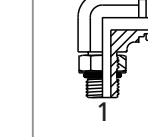
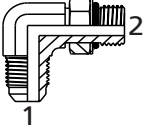
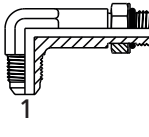



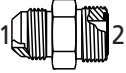
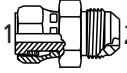
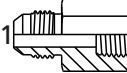
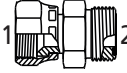
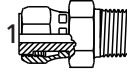

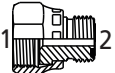
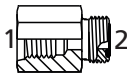

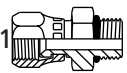
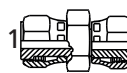
ORB ADAPTERS

<p>3218 (6410)</p> <p>M.ORB - F.ORB</p> 	<p>3239 (6404)</p> <p>F.ORB - M.NPT</p> 	<p>3249 (6401)</p> <p>M.ORB - M.NPT</p> 	<p>3250</p> <p>M.ORB - M.NPT LONG</p> 	<p>3269 (6405)</p> <p>M.ORB - F.NPT</p> 	<p>3298 (6815)</p> <p>M.ORB - F.ORB 90°</p> 
<p>3318 (6425)</p> <p>F.ORB - F.ORB</p> 	<p>3319 (6420)</p> <p>F.ORB - F.NPT</p> 	<p>3449 (6806)</p> <p>M.ORB - M.NPT 90°</p> 	<p>3459 (6805)</p> <p>M.ORB - F.NPT 90°</p> 	<p>3469 (6805LL)</p> <p>M.ORB - F.NPT 90° - X-LONG</p> 	<p>3715 (6832)</p> <p>M.ORB - F.ORB T</p> 
<p>3716 (6835)</p> <p>M.ORB - F.ORB T</p> 	<p>5214 (6464)</p> <p>M.ORB - M.ORB</p> 	<p>5214L (6464L)</p> <p>M.ORB - M.ORB LONG</p> 	<p>5215 (2474)</p> <p>ADJ. M.ORB - M.ORB</p> 	<p>5216 (3474LLL)</p> <p>ADJ. M.ORB - M.ORB LONG</p> 	<p>5245 (6808)</p> <p>M.ORB - M.ORB 45°</p> 
<p>5295 (6807)</p> <p>M.ORB - M.ORB 90°</p> 	<p>5297 (6807LL)</p> <p>M.ORB - M.ORB 90° - LONG</p> 	<p>5315 (6400)</p> <p>M.JIC - M.ORB</p> 	<p>5316 (6400L)</p> <p>M.JIC - M.ORB LONG</p> 	<p>5317 (6400LL)</p> <p>M.JIC - M.ORB X-LONG</p> 	<p>5365 (6802)</p> <p>M.JIC - M.ORB 45°</p> 

ORB ADAPTERS

<p>5515 (6801)</p> <p>M.JIC - M.ORB 90°</p> 	<p>5515L (6801L)</p> <p>M.JIC - M.ORB 90°</p> 	<p>5516 (6801LL)</p> <p>M.JIC - M.ORB 90° X-LONG</p> 	<p>5517 (6801LL)</p> <p>M.JIC - M.ORB 90° XX-LONG</p> 	<p>5715 (6803)</p> <p>M.JIC - M.ORB T</p> 	<p>5716 (6803)</p> <p>M.JIC - M.ORB T</p> 
<p>5716L (6804L)</p> <p>M.JIC - M.ORB T - LONG</p> 	<p>5720 (6840)</p> <p>M.JIC - M.ORB T</p> 	<p>5916 (6850)</p> <p>M.JIC - M.ORB T</p> 	<p>7237 (6408)</p> <p>HEX PLUG M.ORB</p> 	<p>7238 (6409)</p> <p>PLUG ALLEN M.ORB</p> 	<p>9315 (6900)</p> <p>M.ORB - F.NPSM</p> 
<p>9316 (6402)</p> <p>M.ORB - F.JIC</p> 	<p>9346 (6810)</p> <p>M.ORB - F.JIC 45°</p> 	<p>9365 (6902)</p> <p>M.ORB - F.NPSM 45°</p> 	<p>9415 (6911)</p> <p>M.ORB - F.NPSM T</p> 	<p>9515 (6901)</p> <p>M.ORB - F.NPSM 90°</p> 	<p>9516 (6809)</p> <p>M.ORB - F.JIC 90°</p> 
<p>BLANK5315 (6400B)</p> <p>M.JIC - M.ORB RESTRICTOR</p> 	<p>RES5315 (6400R)</p> <p>M.JIC - M.ORB RESTRICTOR</p> 				

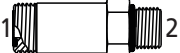
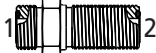
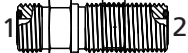
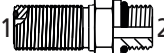
ORFS ADAPTERS

4005 (FS6403) M.JIC - M.ORFS 	4100 (FS6504) F.ORFS - M.JIC 	4100F M.JIC - F.ORFS 	4101 (FS6402) F.JIC - M.ORFS 	4102 (FS6505) F.ORFS - M.NPT 	4105 (FS0318) NUT F.ORFS 
4109 (FS2406) F.ORFS - M.ORFS 	4109F (FS2406F) F.ORFS - M.ORFS 	4129 (FS0304C) CAP ORFS 	4115 (FS6540) F.ORFS - M.ORB 	4156 (FS6565) F.ORFS - F.ORFS 	4165 (FS0319) SLEEVE ORFS 
4205 (FS2404) M.ORFS - M.NPT 	4218 (FS6410R) M.ORFS - F.ORB 	4229 (FS2408) PLUG ORFS 	4255 (FS2405) M.ORFS - F.NPT 	4305 (FS2403) M.ORFS - M.ORFS 	4315 (FS6400) M.ORFS - M.ORB 
4316 (FS6400L) M.ORFS - M.ORB LONG 	4325 (FS2700) M.ORFS - M.ORFS BH 	4325LN (FS2700LN) M.ORFS - M.ORFS BH C/W LN 	4328 (FS2764R) M.ORFS - M.ORB BH 	4328LN (FS2764LN) M.ORFS - M.ORB BH C/W LN 	4355 (FS2503) M.ORFS - M.NPT 45° 

ORFS ADAPTERS

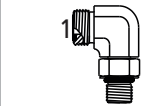
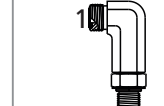
<p>4356 (FS6502)</p> <p>F.ORFS - M.ORFS 45°</p> 	<p>4365 (FS6802)</p> <p>M.ORFS - M.ORB 45°</p> 	<p>4375 (FS2702)</p> <p>M.ORFS - M.ORFS 45° - BH</p> 	<p>4375LN (FS2702LN)</p> <p>M.ORFS - M.ORFS 45° - BH C/W LN</p> 	<p>4403 (FS0403)</p> <p>BORE - M.ORFS</p> 	<p>4405 (FS2501)</p> <p>M.ORFS - M.NPT 90°</p> 
<p>4455 (FS6503)</p> <p>F.ORFS - F.NPT 90°</p> 	<p>4505 (FS2500)</p> <p>M.ORFS - M.ORFS 90°</p> 	<p>4506 (FS6500)</p> <p>F.ORFS - M.ORFS 90°</p> 	<p>4515 (FS6801)</p> <p>M.ORFS - M.ORB 90°</p> 	<p>4516 (FS6801L)</p> <p>M.ORFS - M.ORB 90° - LONG</p> 	<p>4516L (FS6801LL)</p> <p>M.ORFS - M.ORB 90° - X-LONG</p> 
<p>4517 (FS6809)</p> <p>F.ORFS - M.ORB 90°</p> 	<p>4525 (FS2701)</p> <p>M.ORFS - M.ORFS 90° - BH</p> 	<p>4525LN (FS2701LN)</p> <p>M.ORFS - M.ORFS 90° - BH C/W LN</p> 	<p>4605 (FS2601)</p> <p>M.ORFS - M.NPT T</p> 	<p>4639 (FS6001)</p> <p>SILVER BRAZE RING</p> 	<p>4705 (FS2603)</p> <p>M.ORFS T</p> 
<p>4706 (FS6602)</p> <p>F.ORFS - M.ORFS T</p> 	<p>4707 (FS6600)</p> <p>F.ORFS - M.ORFS T</p> 	<p>4715 (FS6803)</p> <p>M.ORFS - M.ORB T</p> 	<p>4715L (FS6803L)</p> <p>M.ORFS - M.ORB T - LONG</p> 	<p>4716 (FS6804)</p> <p>M.ORFS - M.ORB T</p> 	<p>4725 (FS2703)</p> <p>M.ORFS T - BH</p> 







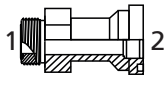
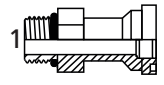
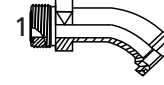
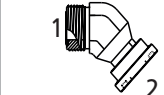
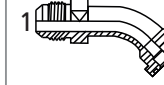
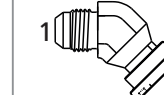
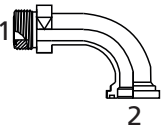
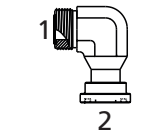
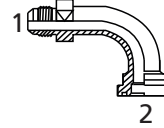
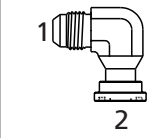
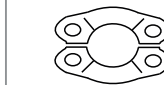

ORFS ADAPTERS

4725LN (FS2703LN) M.ORFS T - BH C/W LN	4726 (FS2704) M.ORFS T - BH	4726LN (FS2404LN) M.ORFS T - BH C/W LN	4755 (FS2605) M.ORFS - M.NPT T	4915 (FS6859) F.ORFS - M.ORB CROSS	4955 (FS2650) M.ORFS CROSS
GP4109 (FS6564R) F.ORFS - M.ORFS GAUGE PORT					

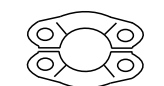

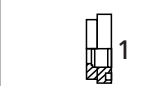
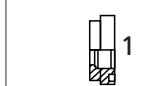
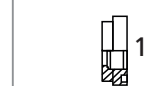
FLANGE ADAPTERS

9713 (1700) M.JIC - FL61	9714 (FS1700) M.ORFS - FL61	9718 (1710) M.ORB - FL61	9743 (1703) M.JIC - FL61 45°	9743F (1703F) M.JIC - FL61 45°	9744 (FS1703) M.ORFS - FL61 45°
9744F (FS1703) M.ORFS - FL61 45°	9793 (1704) M.JIC - FL61 90°	9793F (1704F) M.JIC - FL61 90°	9794 (FS1704) F.ORFS - FL61 90°	9794F (FS1704F) F.ORFS - FL61 90°	9816 (1800) M.JIC - FL62

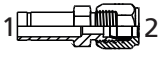
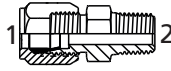
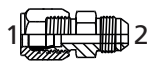
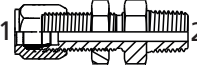

FLANGE ADAPTERS

<p>9814 (FS1800)</p> <p>M.ORFS - FL62</p> 	<p>9818 (1810)</p> <p>M.ORB - FL62</p> 	<p>9844 (FS1803)</p> <p>M.ORFS - FL62 45°</p> 	<p>9844F (FS1803F)</p> <p>M.ORFS - FL62 45°</p> 	<p>9846 (1803)</p> <p>M.JIC - FL62 45°</p> 	<p>9846F (1803F)</p> <p>M.JIC - FL62 45°</p> 
<p>9894 (FS1704)</p> <p>M.ORFS - FL62 90°</p> 	<p>9894F (FS1804F)</p> <p>M.ORFS - FL62 90°</p> 	<p>9896 (1804)</p> <p>M.JIC - FL62 90°</p> 	<p>9896F (1804F)</p> <p>M.JIC - FL62 90°</p> 	<p>9903 (1901)</p> <p>SPLIT FL61</p> 	<p>9903K (1901K)</p> <p>SPLIT FL61 KIT</p> 
<p>9906 (1902)</p> <p>SPLIT FL62</p> 	<p>9906K (1902K)</p> <p>SPLIT FL62 KIT</p> 	<p>9909</p> <p>SPLIT FL CAT KIT</p> 	<p>FOP</p> <p>PUCK FL61</p> 	<p>FOPX</p> <p>PUCK FL62</p> 	<p>FOPCAT</p> <p>PUCK FL CAT</p> 
<p>K61 (1900-61)</p> <p>BOLT KIT FL61</p> 	<p>K62 (1900-62)</p> <p>BOLT KIT FL62</p> 	<p>KMETRIC (1900-M)</p> <p>BOLT METRIC</p> 			

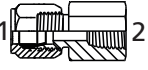
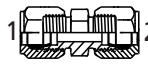
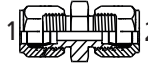
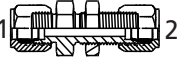
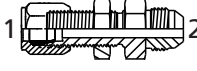
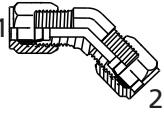
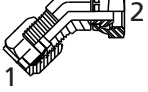
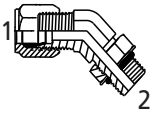
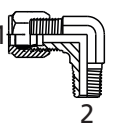
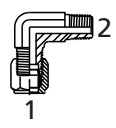
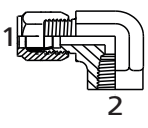
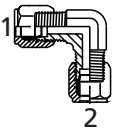



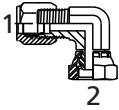
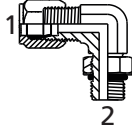
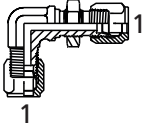
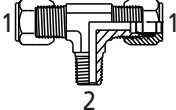
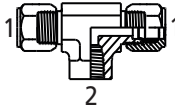
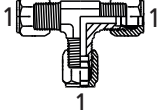
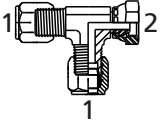
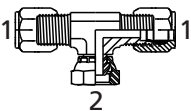
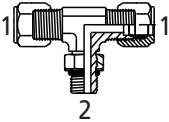
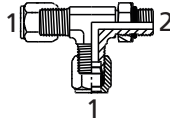
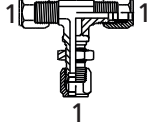
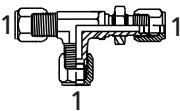
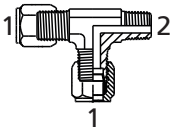
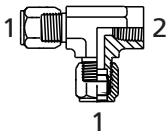

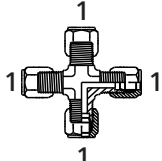

STANDARD FLARELESS ADAPTERS

<p>7015 (C2406)</p> <p>TUBE-M.FL.LESS</p> 	<p>7105 (C0318)</p> <p>NUT FLARELESS</p> 	<p>7129 (C0304C)</p> <p>CAP FLARELESS</p> 	<p>7165 (C0319)</p> <p>SLEEVE FLARELESS</p> 	<p>7205 (C2404)</p> <p>M.FL.LESS - M.NPT</p> 	<p>7207 (C2402)</p> <p>M.FL.LESS - M.JIC</p> 
<p>7225 (C2706)</p> <p>M.FL.LESS - M.NPT BH</p> 	<p>7229 (C2408)</p> <p>PLUG FLARELESS</p> 	<p>7255 (C2405)</p> <p>M.FL.LESS - F.NPT</p> 	<p>7305 (C2403)</p> <p>UNION M.FL.LESS</p> 	<p>7306 (C2403LH)</p> <p>UNION LARGE HEX M.FL.LESS</p> 	<p>7315 (C6400)</p> <p>M.FL.LESS - M.ORB</p> 
<p>7325 (C2700)</p> <p>M.FL.LESS BH</p> 	<p>7327 (C2707)</p> <p>M.FL.LESS - M.JIC</p> 	<p>7345 (C2504)</p> <p>UNION M.FL.LESS 45°</p> 	<p>7355 (C2503)</p> <p>M.FL.LESS - M.NPT 45°</p> 	<p>7356 (C6502)</p> <p>M.FL.LESS - F.FL.LESS</p> 	<p>7365 (C6802)</p> <p>M.FL.LESS - M.ORB 45°</p> 
<p>7375 (C2702)</p> <p>M.FL.LESS 45° - BH</p> 	<p>7405 (C2501)</p> <p>M.FL.LESS - M.ORB 90°</p> 	<p>7435 (C2501L)</p> <p>M.FL.LESS - M.NPT 90°</p> 	<p>7436 (C2501LL)</p> <p>M.FL.LESS - M.NPT 90°</p> 	<p>7455 (C2502)</p> <p>M.FL.LESS - F.NPT 90°</p> 	<p>7505 (C2500)</p> <p>M.FL.LESS 90°</p> 

STANDARD FLARELESS ADAPTERS

<p>7506 (C6500)</p> <p>M.FL.LESS - F.FL.LESS 90°</p> 	<p>7515 (C6801)</p> <p>M.FL.LESS - M.ORB 45°</p> 	<p>7525 (C2701)</p> <p>M.FL.LESS - M.FL.LESS 90°</p> 	<p>7605 (C2601)</p> <p>M.FL.LESS - M.NPT T</p> 	<p>7655 (C2602)</p> <p>M.FL.LESS - F.NPT T</p> 	<p>7705 (C2603)</p> <p>M.FL.LESS T</p> 
<p>7706 (C6602)</p> <p>M.FL.LESS - F.FL.LESS T</p> 	<p>7707 (C6600)</p> <p>M.FL.LESS - F.FL.LESS T</p> 	<p>7715 (C6803)</p> <p>M.FL.LESS - M.ORB T</p> 	<p>7716 (C2603)</p> <p>M.FL.LESS - M.ORB T</p> 	<p>7725 (C2703)</p> <p>M.FL.LESS T - BH</p> 	<p>7726 (C2704)</p> <p>M.FL.LESS T - BH</p> 
<p>7755 (C2605)</p> <p>M.FL.LESS - M.NPT T</p> 	<p>7805 (C2606)</p> <p>M.FL.LESS - F.NPT T</p> 	<p>7924 (C0306)</p> <p>BH NUT M.FL.LESS</p> 	<p>7955 (C2650)</p> <p>M.FL.LESS CROSS</p> 		

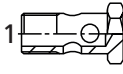
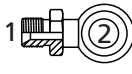
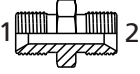
BSP ADAPTERS

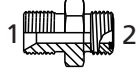
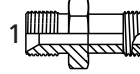
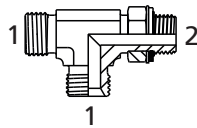
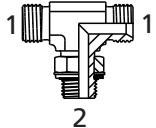
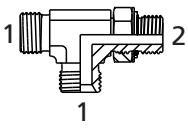
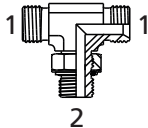
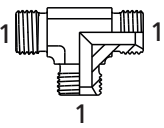
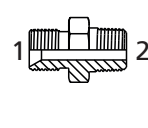
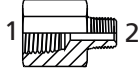
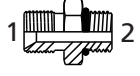
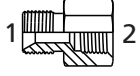
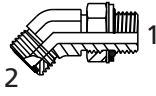
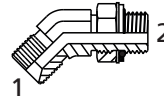
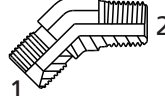
40510 (9522P) PLUG M.BSPP	40511 (8555P) PLUG M.METRIC	40610 (9522H) HOLLOW HEX PLUG M.BSPP	40710 (9500P) PLUG M.BSPT	40711 PLUG HOLLOW M.BSPT	41300 (9644C) CAP F.BSPP
					
80210 BANJO BOLT M.BSPP	80503 M.BSPP - BANJO BSPP	80505 (9022) M.BSPP - M.BSPP	80513 (9023) M.BSPP - F.BSPP	80514 M.BSPP - M.ORFS	80514L M.BSPP - M.ORFS LONG
					
80516 M.BSPP - M.ORB T	80517 M.BSPP - M.ORB T	80518 M.BSPP - M.BSPP T - ADJ.	80519 M.BSPP - M.BSPP T - ADJ.	80520 (9322) M.BSPP - M.BSPP T	80528 (7032) M.BSPP - M.NPT
					
80529 (7033) F.BSPP - M.NPT	80530 (7062) M.BSPP - M.ORB	80531 M.BSPP - F.ORB	80544 M.BSPP - M.ORFS 45°	80545 M.BSPP - M.BSPP 45°	80547 M.BSPP - M.BSPT 45°
					



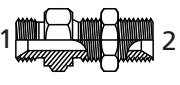
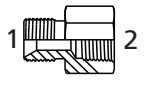
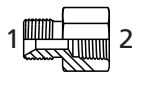
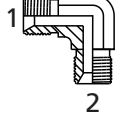
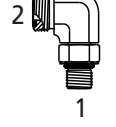
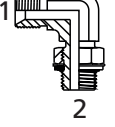
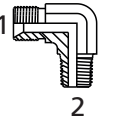
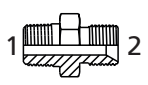
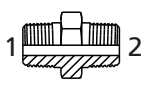
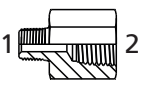
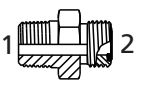
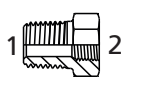
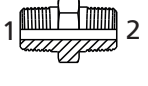
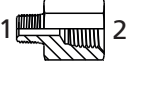
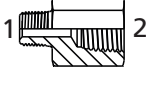
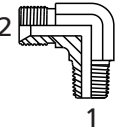
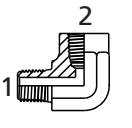
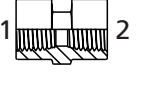
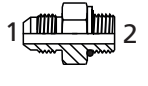
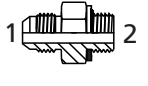
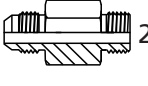
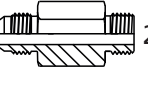
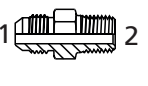
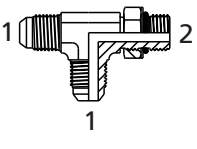



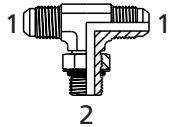
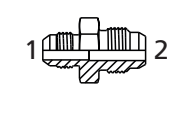
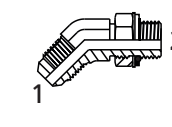
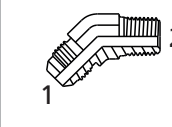
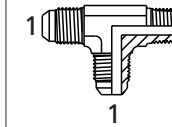
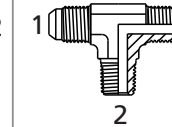
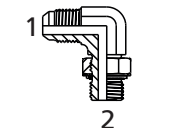
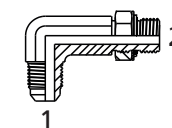
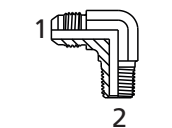
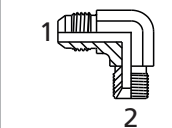
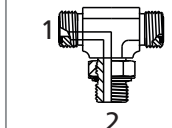
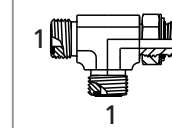
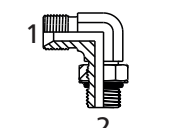
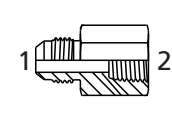
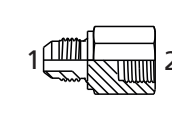
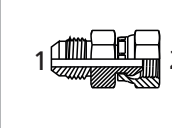
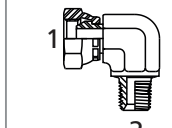
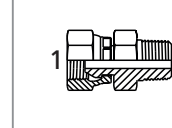
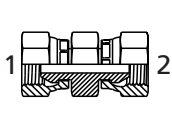
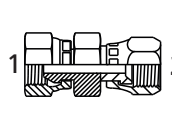
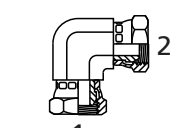
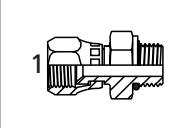
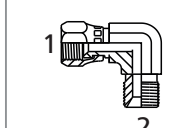
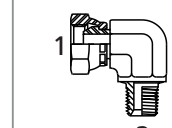

BSP ADAPTERS

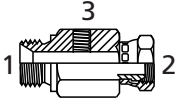
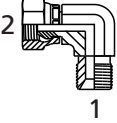
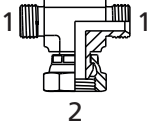
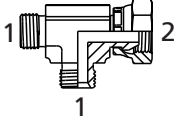
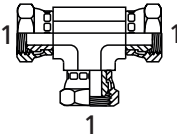
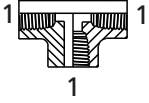
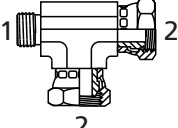
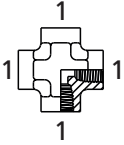
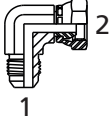
<p>80560 (9722LN)</p> <p>M.BSPP BULKHEAD</p> 	<p>80570</p> <p>M.BSPP - F.BSPT</p> 	<p>80582 (7042)</p> <p>M.BSPP - F.NPT</p> 	<p>80590 (9222)</p> <p>M.BSPP - M.BSPP 90°</p> 	<p>80594</p> <p>M.ORFS - M.BSPP 90° - ADJ.</p> 	<p>80595</p> <p>M.BSPP - M.BSPP 90° - ADJ.</p> 
<p>80598</p> <p>M.BSPP - M.NPT 90°</p> 	<p>80705 (9020)</p> <p>M.BSPT - M.BSPP</p> 	<p>80707 (9000)</p> <p>M.BSPT - M.BSPT</p> 	<p>80713</p> <p>M.BSPT - F.BSPP</p> 	<p>80714</p> <p>M.BSPT - M.ORFS</p> 	<p>80717 (9001)</p> <p>M.BSPT - F.BSPT</p> 
<p>80728 (7030)</p> <p>M.BSPT - M.NPT</p> 	<p>80731</p> <p>M.BSPT - F.ORB</p> 	<p>80782 (7040)</p> <p>M.BSPT - F.NPT</p> 	<p>80795</p> <p>M.BSPT - M.BSPT 90°</p> 	<p>80797 (9002)</p> <p>M.BSPT - F.BSPT 90°</p> 	<p>81313 (9033)</p> <p>F.BSPP UNION</p> 
<p>82505 (7002)</p> <p>M.JIC - M.BSPP</p> 	<p>82505ED</p> <p>M.JIC - M.BSPP ED SEAL</p> 	<p>82505L</p> <p>M.JIC - M.BSPP LONG</p> 	<p>82505XL</p> <p>M.JIC - M.BSPP X-LONG</p> 	<p>82507 (7000)</p> <p>M.JIC - M.BSPT</p> 	<p>82518</p> <p>M.JIC - M.BSPP T</p> 

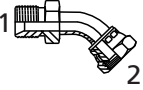
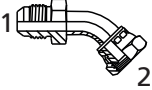

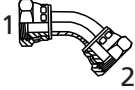
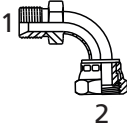
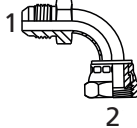
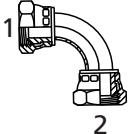







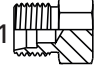

BSP ADAPTERS

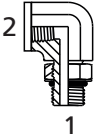
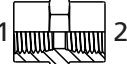
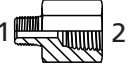
<p>82519</p> <p>M.JIC - M.BSPP T</p> 	<p>82540 (7009)</p> <p>M.JIC - M.KOMATSU T</p> 	<p>82545 (7102)</p> <p>M.JIC - M.BSPP 45°</p> 	<p>82547 (7100)</p> <p>M.JIC - M.BSPT 45°</p> 	<p>82557</p> <p>M.JIC - M.BSPT T</p> 	<p>82558</p> <p>M.JIC - M.BSPT T</p> 
<p>82595 (7202)</p> <p>M.JIC - M.BSPP 90°</p> 	<p>82595L</p> <p>M.JIC - M.BSPP 90° - LONG</p> 	<p>82597 (7200)</p> <p>M.JIC - M.BSPT 90°</p> 	<p>82599</p> <p>M.JIC - M.BSPP 90°</p> 	<p>84420</p> <p>M.ORFS - M.BSPP 90° - T</p> 	<p>84421</p> <p>M.ORFS - M.BSPP 90° - T</p> 
<p>90530</p> <p>M.BSPP - M.ORB 90°</p> 	<p>92513 (7003)</p> <p>M.JIC - F.BSPP</p> 	<p>92550</p> <p>M.JIC - F.BSPP</p> 	<p>92551 (7004)</p> <p>M.JIC - F.BSPP</p> 	<p>92851</p> <p>F.BSPP - M.NPT 90°</p> 	<p>95128</p> <p>F.BSPP - M.NPT</p> 
<p>95151</p> <p>F.BSPP UNION</p> 	<p>95152 (7023)</p> <p>F.BSPP - F.JIC UNION</p> 	<p>95191</p> <p>F.BSPP - F.BSPP 90°</p> 	<p>95205 (7022)</p> <p>F.JIC - M.BSPP</p> 	<p>95295 (7222)</p> <p>F.JIC - M.BSPP 90°</p> 	<p>95297</p> <p>F.BSPP - M.BSPT 90°</p> 

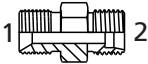
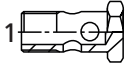

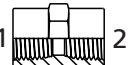
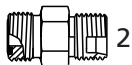
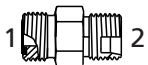
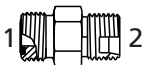

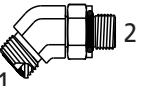
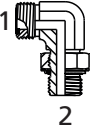
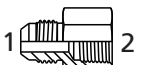





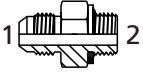

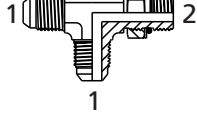
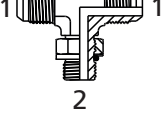
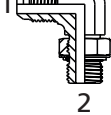
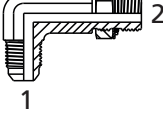
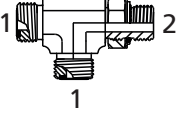
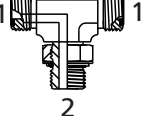

BSP ADAPTERS

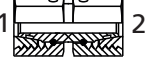
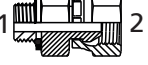
<p>95511 (9024)</p> <p>M.BSPP - F.BSPP</p> 	<p>95511TP</p> <p>M.BSPP - F.BSPP 1/8" F.BSPP (Test Port)</p> 	<p>95519 (9224)</p> <p>BSPP - F.BSPP (Gage Port)</p> 	<p>95520</p> <p>M.BSPP - F.BSPP T</p> 	<p>95521</p> <p>M.BSPP - F.BSPP T</p> 	<p>95522 (9344)</p> <p>F.BSPP T</p> 
<p>95522F</p> <p>F.BSPP T</p> 	<p>95523</p> <p>M.BSPP - F.BSPP T</p> 	<p>95524</p> <p>F.BSPP CROIX</p> 	<p>95551 (7204)</p> <p>M.JIC - F.BSPP 90°</p> 	<p>96000 (9900)</p> <p>BOUNDED SEAL BSPP</p> 	<p>96000V</p> <p>BOUNDED SEAL BSPP VITON</p> 
<p>97055 (9124)</p> <p>M.BSPP - F.BSPP 45°</p> 	<p>97255</p> <p>M.JIC - F.BSPP 45°</p> 	<p>97511</p> <p>F.BSP - M.BSPT</p> 	<p>97515</p> <p>F.BSPP - F.BSPP 45°</p> 	<p>98055 (9224L)</p> <p>M.BSPP - F.BSPP 90°</p> 	<p>98255</p> <p>M.JIC - F.BSPP 90°</p> 
<p>98515</p> <p>F.BSPP - F.BSPP 90°</p> 	<p>9041 (9925)</p> <p>LOCK NUT BSPP</p> 	<p>JC</p> <p>COPPER WASHER</p> 	<p>RR</p> <p>RETAINING RING</p> 		

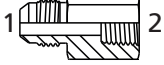
METRIC ADAPTERS

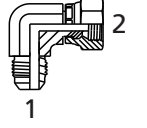
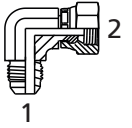
40611 (8555H) M.METRIC PLUG 	41000 METRIC TUBE PLUG 	41010 FRENCH TUBE PLUG 	41011 FRENCH TUBE CAP 	80030 (7045) M.METRIC - F.NPT 	80039 M.METRIC - F.NPT 
80101 F.METRIC UNION 	80128 M.NPT - F.METRIC 	80131 M.METRIC - F.ORB 	80510 (9025) M.BSPP - M.METRIC 	80810 M.METRIC BANJO BOLT 	81001 M.METRIC - F.METRIC 
81010 (8055) M.METRIC - M.METRIC 	81382 F.BSPP - F.NPT 	81411-DP M.ORFS - M.METRIC (L) 	81412-DP M.ORFS - M.METRIC (S) 	81418 M.ORFS - M.METRIC FRENCH 	81421 (FS7640) M.ORFS - M.METRIC 
81421ED (FS7701) M.ORFS - M.METRIC 	81441 (FS7300) M.ORFS - M.METRIC 45° 	81491 M.ORFS - M.METRIC 90° 	82502 M.JIC - F.METRIC 	82511-DP (7005-L) M.JIC - M.METRIC DUAL (L) 	82512-DP (7005-S) M.JIC - M.METRIC DUAL (S) 

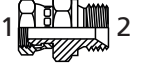
METRIC ADAPTERS

<p>82521 (7001)</p> <p>M.JIC - M.METRIC</p> 	<p>82541</p> <p>M.JIC - M.METRIC 45°</p> 	<p>82561</p> <p>M.JIC - M.METRIC T</p> 	<p>82562</p> <p>M.JIC - M.METRIC T</p> 	<p>82591 (7205)</p> <p>M.JIC - M.METRIC 90°</p> 	<p>82591L</p> <p>M.JIC - M.METRIC 90° - LONG</p> 
<p>84410</p> <p>M.ORFS - M.METRIC T</p> 	<p>84411</p> <p>M.ORFS - M.METRIC T</p> 	<p>82821DP</p> <p>M.NPT - M.METRIC (L/S)</p> 	<p>88201</p> <p>F.NPT - F.METRIC</p> 	<p>88211DP</p> <p>F.NPT - M.METRIC (L)</p> 	<p>88212DP</p> <p>F.NPT - M.METRIC (S)</p> 
<p>91010L/S</p> <p>F.METRIC UNION</p> 	<p>91011</p> <p>M.METRIC - F.BSPP</p> 	<p>92515 (7007-L)</p> <p>M.JIC - F.METRIC (L)</p> 	<p>92515F</p> <p>M.JIC - F.METRIC</p> 	<p>92516 (7007-S)</p> <p>M.JIC - F.METRIC (S)</p> 	<p>92595</p> <p>M.JIC - F.METRIC 90° - (L)</p> 
<p>92596</p> <p>M.JIC - F.METRIC 90° (S)</p> 	<p>95200 (7025)</p> <p>F.JIC - M.METRIC</p> 	<p>95240</p> <p>F.JIC - F.KOMATSU</p> 	<p>95510</p> <p>F.METRIC - B.BSPP</p> 	<p>97000 (8800)</p> <p>BOUNDED SEAL METRIC</p> 	<p>97000V</p> <p>BOUNDED SEAL METRIC (VITON)</p> 

METRIC ADAPTERS

9200



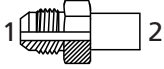

M.JIC - TUBE METRIC





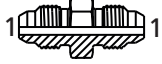
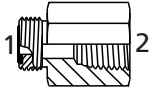
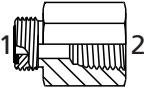
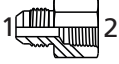
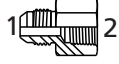

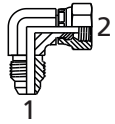
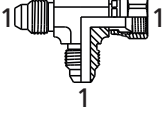
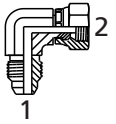
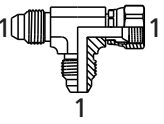
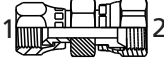

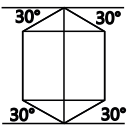
MOBILE APPLICATION ADAPTERS

<p>43810 (7588P)</p> <p>PLUG M.JIS</p>	<p>43811 (7688C)</p> <p>CAP F.JIS</p>	<p>44010 (7599P)</p> <p>PLUG M.KOMATSU</p>	<p>44011 (7699C)</p> <p>CAP F.KOMATSU</p>	<p>81438</p> <p>M.ORFS - M.JIS</p>	<p>81440</p> <p>M.ORFS - M.KOMATSU</p>
<p>82503</p> <p>M.JIC - BANJO BSPP</p>	<p>82509</p> <p>M.JIC - BANJO METRIC</p>	<p>82513</p> <p>M.JIC - M.METRIC DUAL (FRENCH)</p>	<p>82538 (7008)</p> <p>M.JIC - M.JIS</p>	<p>83807 (8080)</p> <p>M.JIS - M.BSPT</p>	<p>83810 (8088)</p> <p>UNION JIS</p>
<p>83830</p> <p>M.JIS - M.ORB</p>	<p>83847 (8180)</p> <p>M.JIS - M.BSPT 45°</p>	<p>83890</p> <p>M.JIS - M.ORB 90°</p>	<p>83895</p> <p>M.JIS - M.BSPP 90°</p>	<p>83897 (8280)</p> <p>M.JIS - M.BSPT 90°</p>	<p>84007</p> <p>M.KOMATSU - M.BSPT</p>













MOBILE APPLICATION ADAPTERS

<p>84040</p> <p>UNION M.KOMATSU</p> 	<p>91438</p> <p>M.ORFS - F.JIS</p> 	<p>91440</p> <p>M.ORFS - F.KOMATSU</p> 	<p>92538 (7008-F)</p> <p>M.JIC - F.JIS</p> 	<p>92540 (7009-F)</p> <p>M.JIC - F.KOMATSU</p> 	<p>92556</p> <p>M.JIC - F.HIAB</p> 
<p>92819</p> <p>M.JIS - F.JIS 90°</p> 	<p>93821</p> <p>M.JIS - F.JIS T</p> 	<p>94019</p> <p>M.KOM. - F.KOM. 90°</p> 	<p>94021</p> <p>M.KOM. - F.KOM T</p> 	<p>94040</p> <p>F.KOM. - F.KOM. UNION</p> 	<p>9777</p> <p>CONV. M.HIAB</p> 
<p>9999</p> <p>CONV. M.JIS</p> 					

O'RING

<p>4629 (FS4000)</p> <p>O'RING ORFS</p> 	<p>4629V (FS4001)</p> <p>O'RING VITON ORFS</p> 	<p>9950</p> <p>O'RING ORB</p> 	<p>9975</p> <p>O'RING FLANGE</p> 	<p>9975V</p> <p>O'RING VITON FLANGE</p> 	<p>OR</p> <p>O'RING BSPP</p> 
--	---	--	---	--	---



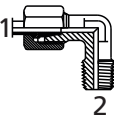
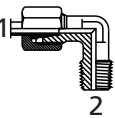
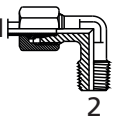
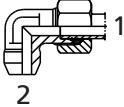
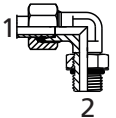
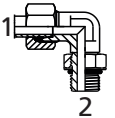
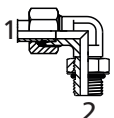
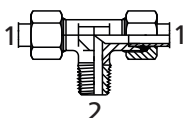
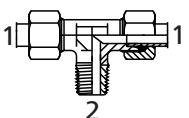
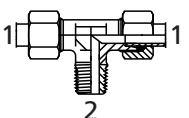
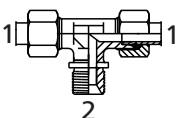
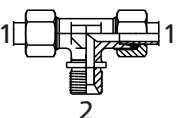

METRIC FLARELESS ADAPTERS

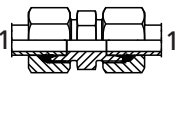
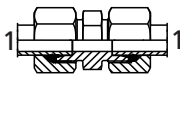
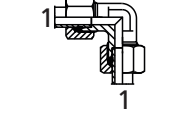
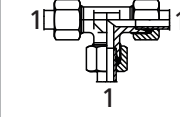
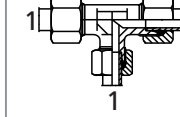
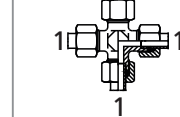
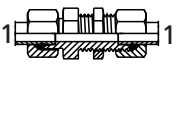
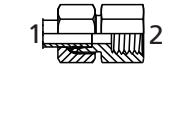
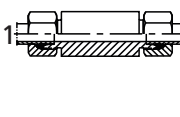
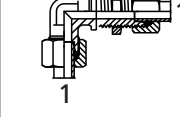
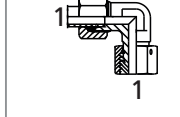
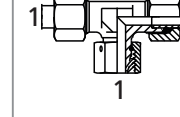
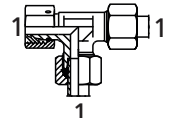
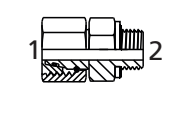
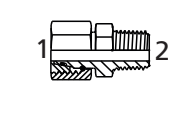
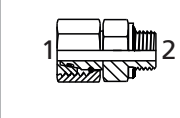
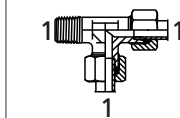
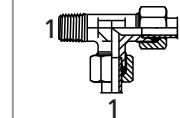
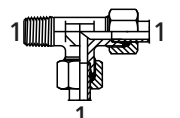
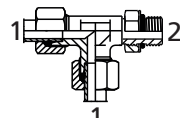
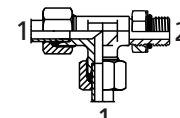
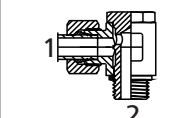
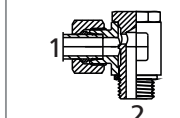
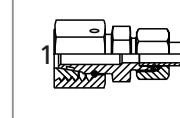
TN81 (D8008) METRIC NUT 	TN88 (D8005) SLEEVE 	TN89 (D8007) DOUBLE SLEEVE 	TN91 M.METRIC WELD 	TN92-M (D8030) M.METRIC - M.METRIC 	TN92-MED (D8031) M.METRIC - M.METRIC 
TN92-ORB (D8051) M.METRIC - M.ORB 	TN92-R (D8040) M.METRIC - M.BSPP 	TN92-RED (D8041) M.METRIC - M.BSPP ED 	TN93-M M.METRIC - M.METRIC TAPER 	TN93-NPT (D8050) M.METRIC - M.NPT 	TN93-R M.METRIC - M.BSPT 
TN94-M (D8233) M.METRIC - M.METRIC 90° 	TN94-NPT (D8250) M.METRIC - M.NPT 90° 	TN94-R (D8243) M.METRIC - M.BSPT 90° 	TN94W M.METRIC - WELD 90° 	TN95-M M.METRIC - M.METRIC 90° 	TN95-R M.METRIC - M.BSPP 90° 
TN95-ORB M.METRIC - M.ORB 90° 	TN96-M (D8433) M.METRIC - M.METRIC T 	TN96-NPT M.METRIC - M.NPT T 	TN96-R (D8443) M.METRIC - M.BSPT BRANCH T 	TN97-M M.METRIC - M.METRIC BRANCH T 	TN97-R M.METRIC - M.BSPP BRANCH T 

METRIC FLARELESS ADAPTERS

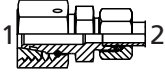
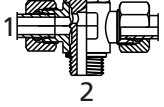
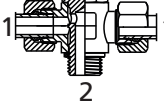
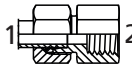
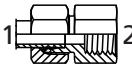
<p>TN98 (D8060)</p> <p>M.METRIC UNION</p> 	<p>TN98R</p> <p>M.METRIC REDUCING UNION</p> 	<p>TN99 (D8263)</p> <p>M.METRIC 90°</p> 	<p>TN100 (D8360)</p> <p>M.METRIC T</p> 	<p>TN100R</p> <p>M.METRIC RED. T</p> 	<p>TN101 (D8660)</p> <p>M.METRIC CROSS</p> 
<p>TN102 (D8061)</p> <p>M.METRIC UNION BULKHEAD</p> 	<p>TN130-R (D8020)</p> <p>M.METRIC - F.BSPP</p> 	<p>TN117</p> <p>M.METRIC WELD BH</p> 	<p>TN118 (D8261)</p> <p>F.METRIC 90° - BH</p> 	<p>TN119 (D8269)</p> <p>M.METRIC - F.METRIC 90°</p> 	<p>TN120 (D8469)</p> <p>M.METRIC - M.BSPP BRANCH T</p> 
<p>TN121 (D8569)</p> <p>M.METRIC - M.METRIC</p> 	<p>TN126-M (D8036)</p> <p>F.METRIC - M.METRIC ED</p> 	<p>TN126-NPT</p> <p>F.METRIC - NPT</p> 	<p>TN126-R (D8046)</p> <p>F.METRIC - M.BSPP ED</p> 	<p>TN127-M</p> <p>M.METRIC - M.BSPP RUN - T</p> 	<p>TN127-NPT</p> <p>M.JIC - F.METRIC 90° - (L)</p> 
<p>TN127-R (D8543)</p> <p>M.METRIC - M.BSPP RUN - T</p> 	<p>TN129-M</p> <p>M.METRIC - M.METRIC RUN - T</p> 	<p>TN129-R</p> <p>M.METRIC - M.BSPP RUN - T</p> 	<p>TN130-M</p> <p>M.METRIC - M.METRIC BANJO</p> 	<p>TN130-R</p> <p>M.METRIC - M.BSPP BANJO</p> 	<p>TN32A-L (D8062)</p> <p>F.METRIC - M.METRIC (L)</p> 

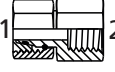
METRIC FLARELESS ADAPTERS

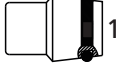
<p>TN132A-S (D8062)</p> <p>F.METRIC - M.METRIC (S)</p> 	<p>TN136-M</p> <p>M.METRIC - M.METRIC T - BANJO</p> 	<p>TN136-R</p> <p>M.METRIC - M.BSPP T - BANJO</p> 	<p>TN147-M (D8034)</p> <p>M.METRIC - F.METRIC</p> 	<p>TN147-R (D8044)</p> <p>M.METRIC - F.BSPP</p> 	<p>TN188 (D8003)</p> <p>CAP METRIC</p> 
<p>TN403-R (D8021)</p> <p>F.METRIC - F.BSPP</p> 	<p>41000 (D8004)</p> <p>PLUG METRIC TUBE</p> 	<p>SKO</p> <p>WELD NIPPLE</p> 			

Other Product Lines

NUVO - PRODUCTS

SWIVEL JOINTS

NUVO - SWIVELS



HYDRAULIC TUBING

NUVO - TUBES



PROTECTIVE GUARDS & SLEEVES

NUVO - GUARDS



Adapters Complete Series

NUVO - CONNECTIONS



Tube Support
& Super Band Clamps

NUVO - CLAMPS

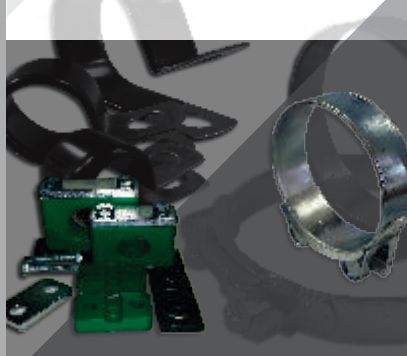

HYDRAULIC HOSES

NUVOFLEX

